

Losange

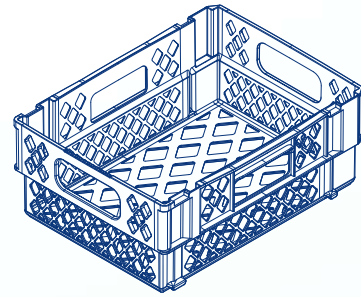

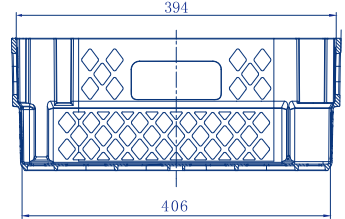

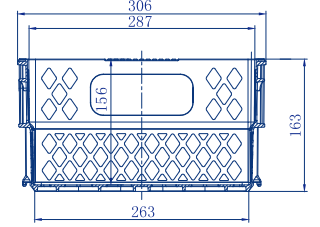

Informations générales - General information - معلومات عامة

		660 ± 5gr
الوزن Weight Poids		
	Dimension extérieures - External sizes - المقاييس الخارجية	406 x 306x163 mm
المقاييس Dimension Volume	Dimension intérieures - Interior sizes - المقاييس الداخلية	394 x 287x 156 mm
		بوليبروبيلان غذائي Alimentary Polypropylène + UV Polypropylène alimentaire + UV
المادة Material Matière		
	ملون حسب رغبة الحريف Color following customer specification Coloré suivant spécification client	يجب استعمال الالوان الباردة Better to use cold colors Eviter les couleurs chaudes
اللون Colour Couleur		
	Manutention - Handling - الترصيف	يرصف و يكوم بالعكس Stackable empilables boxes by reversal Gerbables-empilables par retournement
النوع Type Type		
	Aération - Aeration - التهوية	يضمن التهوية. للترصيف في البراد Guarantee the cold air circulation around all sides of the load Bonne aération pour stockage en chambre froide
التبريد Aeration Aération		
	Manutention - Handling - الاستعمالات	يتحمل الصدمات و التعنف Resist to chock Résistance au choqe et à la vulgarité
الصدمات Hurts Choque		



Informations logestique - Logistics information - التعبئة و الشحن

	Charge Nette - Net charge - الحمولة الصافية	8,5 ± 0,5 kg
الحمولة Charge Charge		
	Conditionnement - Package - الترصيف	10 x 25 pcs
التعبئة Package Emballage	Hauteur pile - Height package - مقاييس الترصيف	2.33 m
	Charge statique - Static loading capacity - الحمولة القصوى	1+8 (250 Kg)
الحمولة Charge Charge	Charge dynamique - Dynamic loading capacity - الشحن الديناميكي	1+8 (120 Kg)
	Contenaire 20 Pied	2250 pcs
الشحن Export Transport	Contenaire 40 Pied	5000 pcs
	Contenaire 40 Pied H.C	5400 pcs

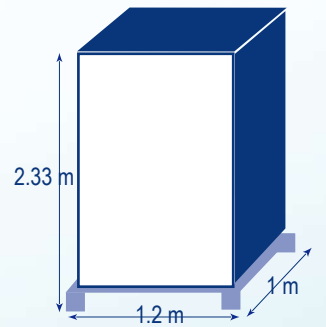

Rq : Les clients sont priés de vérifier et tester nos produits dans des conditions d'utilisation réelles pour s'assurer s'ils répondent à leurs exigences

