

V1

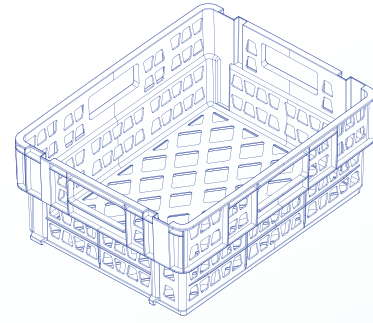

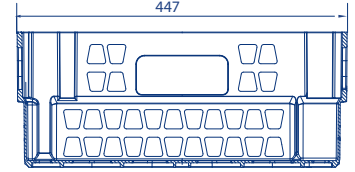
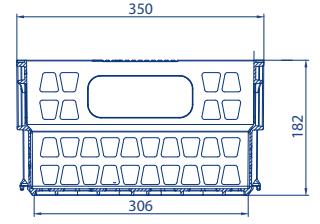

X-Pack

## Informations générales - General information - معلومات عامة

		880 ± 5 gr
الوزن Weight Poids		
	Dimension extérieures - External sizes - المقاييس الخارجية	447x350x182 mm
المقياس Dimension Volume	Dimension intérieure - Interior sizes - المقاييس الداخلية	429x329x175 mm
		بوليبروبيلان غذائي مع حماية من اشعة الشمس Alimentary Polypropylène +UV protection Polypropylène alimentaire + UV protection des rayons uv
المادة Material Matière		
	ملون حسب رغبة الحريف ينصح استعمال الالوان الباردة Color following customer specification recommended to use cold colors Coloré suivant spécification client recommandé d'éviter les couleurs chaudes	
اللون Colour Couleur		
	الترصيف - Handling - Manutention	يرصف و يكوم بالعكس Stackable empilables boxes by reversal Gerbables-empilables par retournement
النوع Type Type		
	التهووية - Aeration - Aération	يضمن التهوية. للترصيف في البراد Guarantee the cold air circulation around all sides of the load Bonne aération pour stockage en chambre froide
التبريد Aeration Aération		
	الاستعمالات - Handling - Manutention	يتحمل الصدمات و التعنف Resist to chock Résistance au choqe et à la vulgarité
الصدمات Hurts Choque		



## Informations logestique - Logistics information - التعبئة و الشحن

	الحمولة الصافية - Net charge - Charge Nette	8,5 ± 0,5 kg
الحمولة Charge Charge		
	الترصيف - Package - Conditionnement	9 x 18 pcs
التعبئة Package Emballage	مقاييس الترسيف - Height pallet - Hauteur palette	1 x 1.2 m - 2.20 m
	الحمولة القصوى - Static loading capacity - Charge statique	1+8 (80 Kg)
الحمولة Charge Charge		
	حاوية 20 قدم - 20 foot container - Contenaire 20 Pied	1656 pcs
التشحن Export Transport	حاوية 40 قدم - 40 foot container - Contenaire 40 Pied	3726 pcs
	حاوية 40 قدم عالي الارتفاع - Height cube 40 foot container - Contenaire 40 Pied H.C	3888 pcs

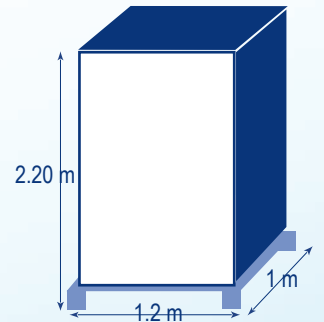

Rq : Les clients sont priés de vérifier et tester nos produits dans des conditions d'utilisation réelles pour s'assurer s'ils répondent à leurs exigences